



佰嘉汇科技

-BAIJIAHUI TECHNOLOGY-

# LED 工矿灯规格书

LED High Bay Light Datasheet



|                   |               |
|-------------------|---------------|
| PRODUCT NAME 产品名称 | 150W 工矿灯      |
| PRODUCT NO 产品型号   | BJH-HL-150W-C |

佰嘉汇科技  
BAIJIAHUI

地址：深圳市宝安区福海街道蚝业路39号旭竟昌工业园B6栋3层  
电话：15989497850 / 0755-23309606  
传真：0755-23309676  
邮箱：szbjhkj@163.com  
网址：www.szbjhkj.com

# 产品规格 (Product Spec) : BJH-HL-150W-C

| 电气特性 (Electrical Characteristics)                           |                                  | 光学特性(Optical Properties)       |                                   |       |
|---|----------------------------------|--------------------------------|-----------------------------------|-------|
| 电源<br>Power Supply  | 茂硕                               | 光源<br>LED Type                 | LUMILEDS<br>2835                  |       |
| 输入电压<br>Input Voltage                                       | AC100-277V /50-60Hz              | 光源数量<br>LED Q' ty              | 240 pcs                           |       |
| 额定功率<br>Rated Power   | 150W                             | 流明值<br>Lumen                   | 24000LM±5%                        |       |
| 功率因素<br>Power Factor  | ≥0.95                            | 显色指数<br>CRI                    | ≥70 Ra                            |       |
| 防护等级<br>Waterproof  | IP65                             | 发光角度<br>Beam Angle             | 60°/90°/120°                      |       |
| 使用寿命<br>Life Time   | ≥50000H                          | 色温<br>CCT                      | 暖白<br>Warm white                  | 3000K |
| 总谐波失真<br>THD  | THD<15%                          |                                | 自然白<br>Natural white              | 4000K |
| 防浪涌等级<br>Anti-surge rating                                  | 6KV                              |                                | 中性白<br>Neutral white              | 5000K |
| IK 防撞等级<br>IK crash rating                                  | IK08                             |                                | 正白<br>Pure white                  | 5700K |
| 外壳喷涂<br>Shell spray   | 户外专用粉末<br>Outdoor special powder |                                | 冷白<br>Cold white                  | 6500K |
| 产品材质 (Product Material)                                     |                                  |                                |                                   |       |
| 电源线<br>Power Wire   | 外壳材质<br>Body material            |                                | 电气安全等级<br>Electronic safety grade |       |
| 3*0.75mm <sup>2</sup> * 0.25M 橡胶线<br>(Rubber cable L=0.25M) | 铝 + PC<br>Aluminum + PC          |                                | I类 (class)                        |       |
| 工作温度<br>Working Temperature                                 |                                  | -30~+60°C                      |                                   |       |
| LED 结温<br>LED Junction Temperature                          |                                  | ≤80°C                          |                                   |       |
| 安全要求<br>Security Requirement                                |                                  | CE                             |                                   |       |
| 环保指令<br>Environmental Directives                            |                                  | ROHS                           |                                   |       |
| 产品尺寸<br>Product Dimension                                   |                                  | Ø308*165mm                     |                                   |       |
| 净重<br>N.W   |                                  | 2.2KG                          |                                   |       |
| 安装方式<br>Installation method                                 |                                  | 吊环安装 (标配) / 支架安装 / 吊杆安装 / 吊链安装 |                                   |       |

## 灯具照度 (Lamp illumination) :

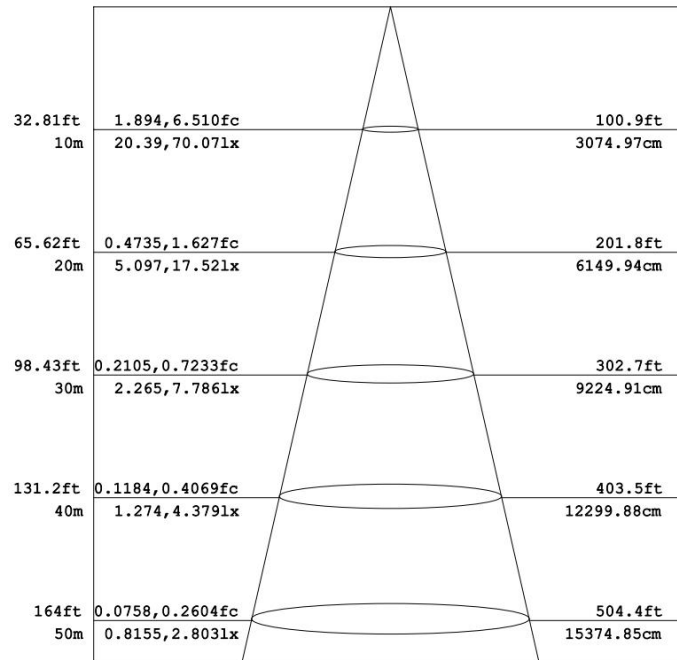

## 光束角度 ( Light Distribution Curves)

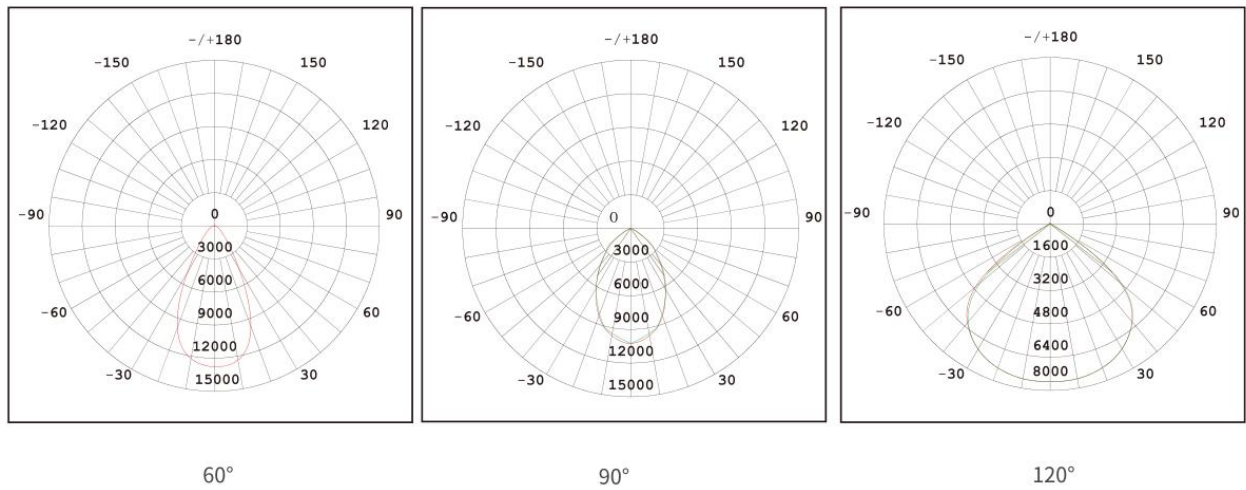

## 灯具尺寸 (Lamp Size) :

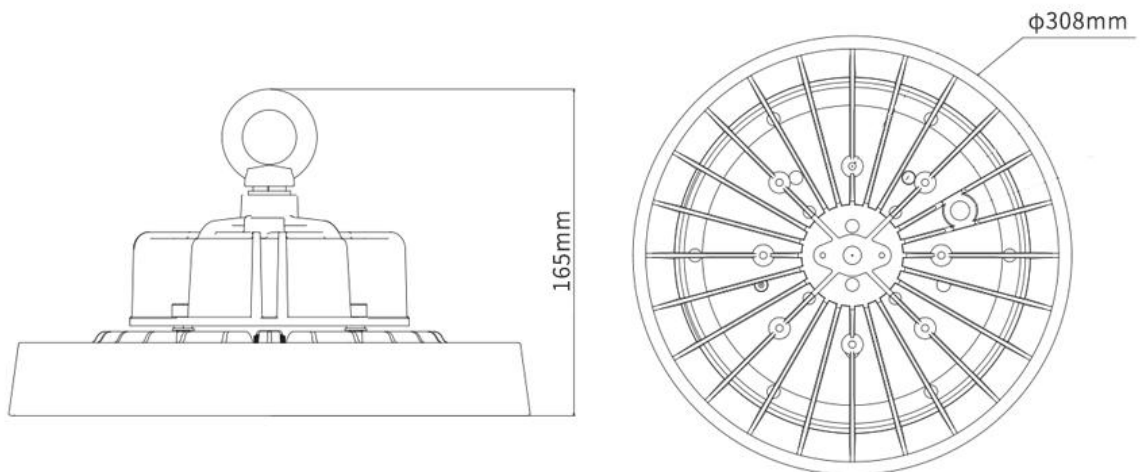

# 包装 (Package) :

外箱尺寸 (Packing Box) : 33\*33\*14CM

装箱数量 (QTY) : 1 PCS/CTN

重量 (G.W) : 2.6 KG

# 安装方式 (Installation method) :

## A: 吊环安装



1. 将挂环旋入后盖的孔

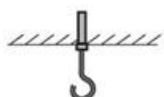

2. 安装挂钩

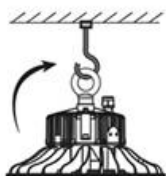

3. 挂灯

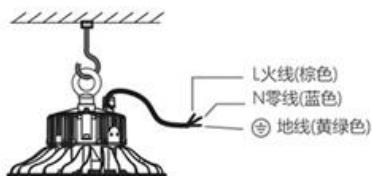

4. 接线

L火线(棕色)  
N零线(蓝色)  
⊕ 地线(黄绿色)

## B: 支架安装

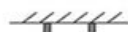

1. 钻孔并打入膨胀螺丝

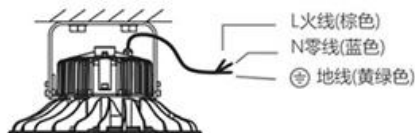

3. 接线

L火线(棕色)  
N零线(蓝色)  
⊕ 地线(黄绿色)

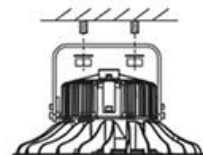

2. 挂灯, 将螺母固定



4. 调整照明角度

## C: 吊杆安装



1. 将螺纹圆管对准安装孔按顺时针旋转进去.

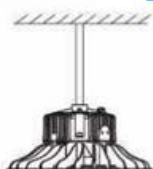

2. 将灯安装固定在天花板实墙上.

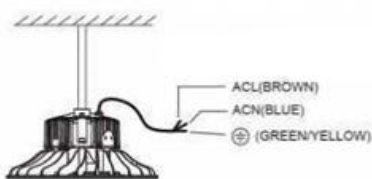

3. 连接好线路.

ACL(BROWN)  
ACN(BLUE)  
⊕ (GREEN/YELLOW)

## B: 吊链安装

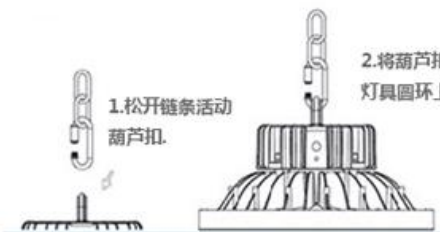

1. 松开链条活动葫芦扣.

2. 将葫芦扣固定在灯具圆环上.

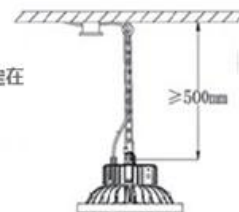

3. 将灯安装固定在天花板实墙上, 并连接好线路, 建议离实墙距离大于500mm