

LED 路灯规格书

LED Street Light Datasheet



PRODUCT NAME 产品名称	300W 路灯
PRODUCT NO 产品型号	BJH-SL-300W-A

产品规格 (Product Spec) : BJH-SL-300W-A

电气特性 (Electrical Characteristics)		光学特性(Optical Properties)		
电源 Power Supply	Normal / MEAN WELL	光源 LED Type	Epistar/ OSRAM /LUMILEDS 3030	
输入电压 Input Voltage	AC100-305V /50-60Hz	光源数量 LED Q' ty	384 pcs	
额定功率 Rated Power	300W	流明值 Lumen	39000LM±5%	
功率因素 Power Factor	0.97	显色指数 CRI	80 Ra	
防护等级 Waterproof	IP66	发光角度 Beam Angle	T2M/T3M/T4M	
使用寿命 Life Time	≥50000H	色温 CCT	warm white	3000K
				4000K
			Natural white	5000K
			Pure white	5700K
			6500K	
产品材质 (Product Material)				
电源线 Power Wire	外壳材质 Body material		电气安全等级 Electronic safety grade	
3*0.75mm²0.5M 橡胶线 (Rubber cable L=0.5M)	铝 + PC + 玻璃 Aluminum + PC + Glass		I类 (class)	
工作温度 Working Temperature		-30~ +60°C		
LED 结温 LED Junction Temperature		≤80°C		
安全要求 Security Requirement		CE		
环保指令 Environmental Directives		ROHS		
产品尺寸 Product Dimension		793*300*109mm		
净重 N.W		7.8KG		
灯杆安装孔径 Light pole installation aperture		Ø40mm / Ø50mm / Ø60mm		

灯具照度 (Lamp illumination) :

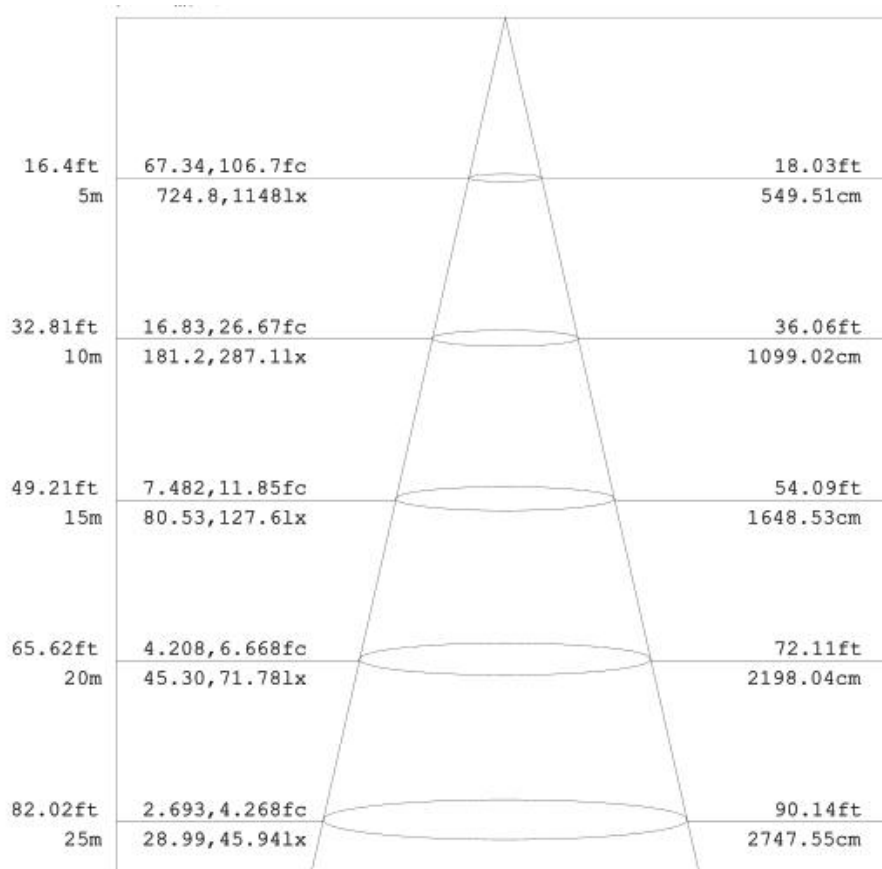

灯具尺寸 (Lamp Size) :

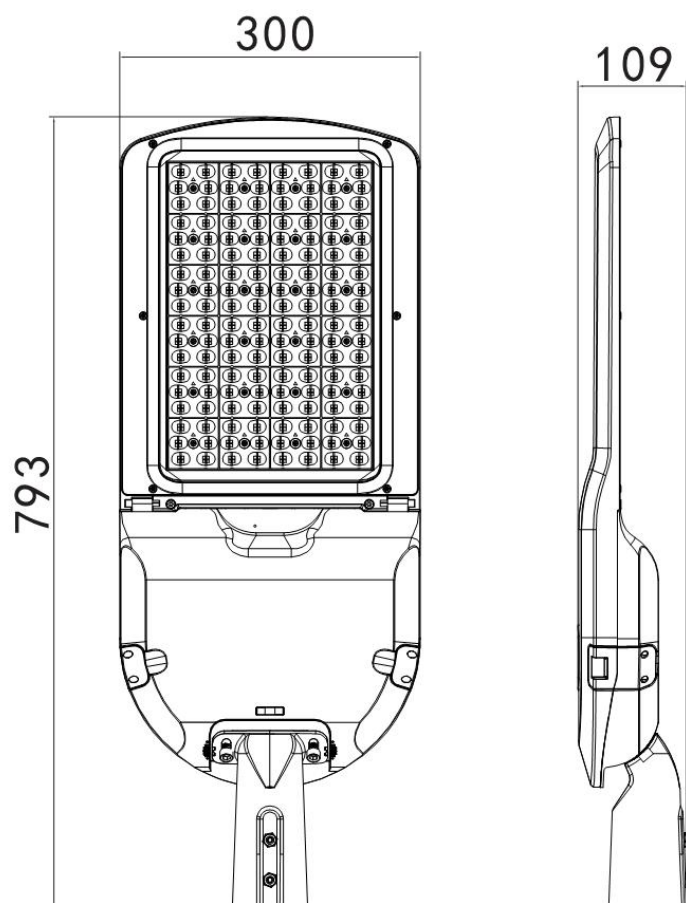

包装 (Package) :

外箱尺寸 (Packing Box) : 85*36*15CM

材质 Material : K=K

装箱数量 (QTY) : 1 PCS/CTN

重量 (G.W) : 8.8 KG